		Materiaal:	Aantal:
		Sheet nr.: 47	Artikelnummer: <b>JAC<sup>2</sup>12HATU</b> optie: JAC <sup>2</sup> HADRMOD
Tekenaar: Rudolf	Getekend: 4-4-2022		Revisie: <b>Jacobus 12 Kwadraat, doorkijk, hangend.</b> Optie: draaibaar aan plafond
Controle: -	Gecontroleerd:		
Schaal: 1 : 10	Maateenheid: Milimeters		
Status: WorkInProgress			
Janco de Jong BV, Tolbaas 2-10, 8401GD Gorredijk. T 0513 571757, E. info@jancodejong.nl, www.jancodejong.nl			

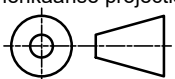
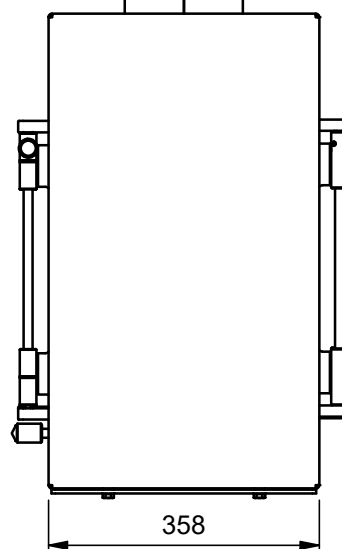
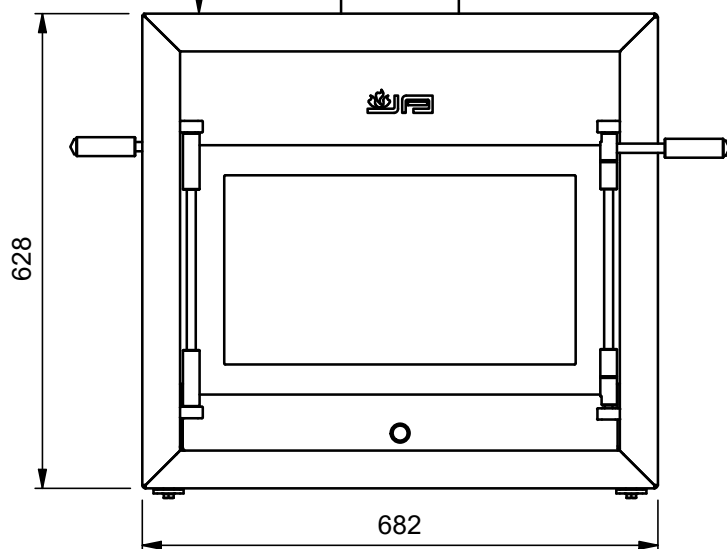
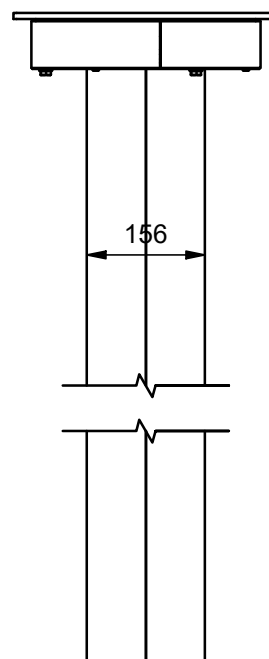
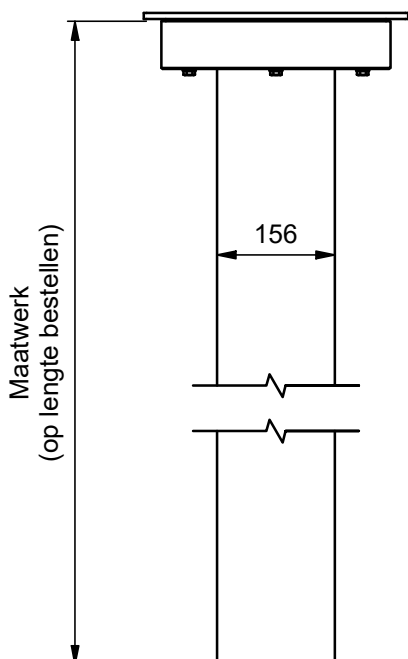
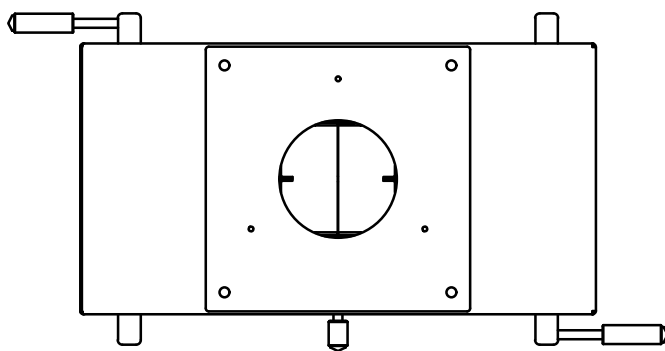

Materiaal:

Aantal:

Sheet nr.: 48

Amerikaanse projectie:

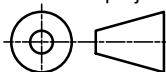

Artikelnummer:

**JAC²12HATU**  
optie: JAC²HADRMOD

Tekenaar: Rudolf

Getekend: 4-4-2022

Controle: -

Gecontroleerd:

Schaal: 1 : 10

Maateenheid: Milimeters

Status: WorkInProgress

Jacobus 12 Kwadraat, doorkijk,  
hangend.  
Optie: draaibaar aan plafond

Revisie:

Formaat:

**A4**